



Thank You for purchasing our Tabletop Paint Station line.

First please carefully unpack the parts and find a flat surface to put all the parts. If you have bought different paint options please try not to mix the parts and assemble one shelf at a time.

Your items may smell of burned wood when you receive them, it will go away with time.

### **Tools that you might need:**

- **Knife**-to cut away excess wood.
- **Nail file**- to sand away rough edges, splinters, and tight-fitting connections.
- **Rubberbands or Masking Tape**- To hold parts in place while the glue sets.
- A **rubber mallet** or a **metal hammer** with a **piece of wood**.

### **GLUE:**

- We recommend using the included glue to secure the parts.
- Most brands of PVA/wood glue can be used.
- Super glue can also be used, but we do not recommend it

### **Assembly tips:**

- Dry fit the parts before gluing.
- You can use a rubber mallet to force some parts into place. Plywood is much sturdier than MDF.
- If you are using a metal hammer, place a piece of wood between the hammer and the part. This will help to prevent scratches and dents.
- Use a moist cloth to wipe away excess glue.
- Use a brush to apply glue with more precision.
- If you are unable to fit parts together, use a nail file to sand away excess material.
- Tray holders don't require glue.
- Do not use strong solvents or isopropyl alcohol on the parts. It can damage the varnish and stain.
- If you need help or have any questions feel free to contact us at [info@frontierwargaming.com](mailto:info@frontierwargaming.com)

Please make yourself familiar with the instructions before assembly.

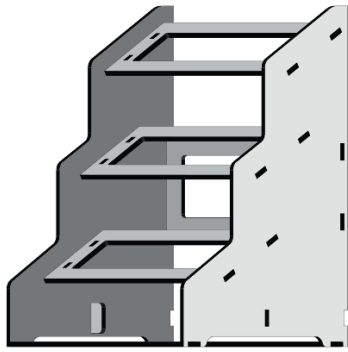

# THE PAINT STAND ASSEMBLY

PARTS:

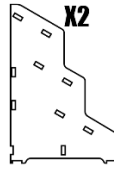

X2

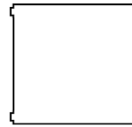

X1

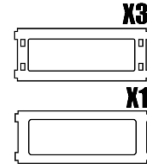

X3



X2

1.

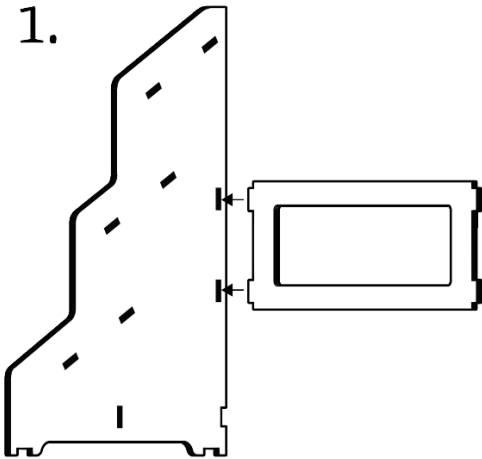

2.

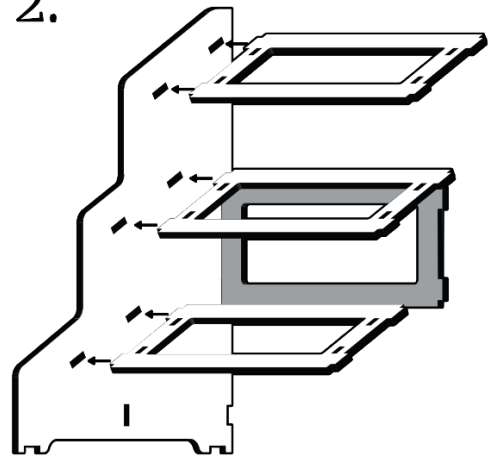

3.

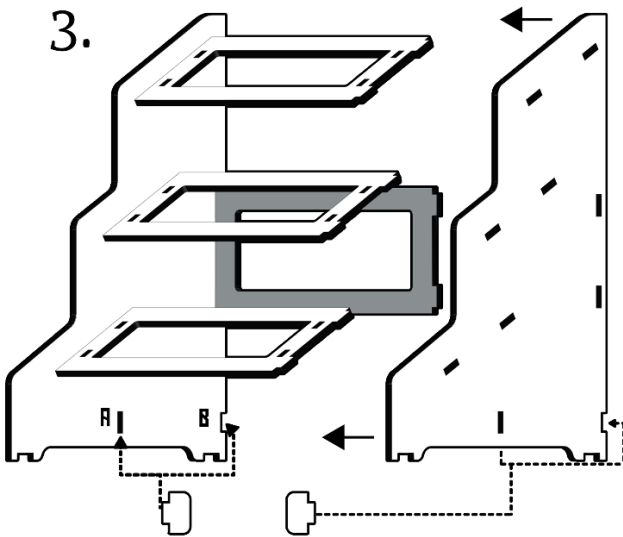

4.

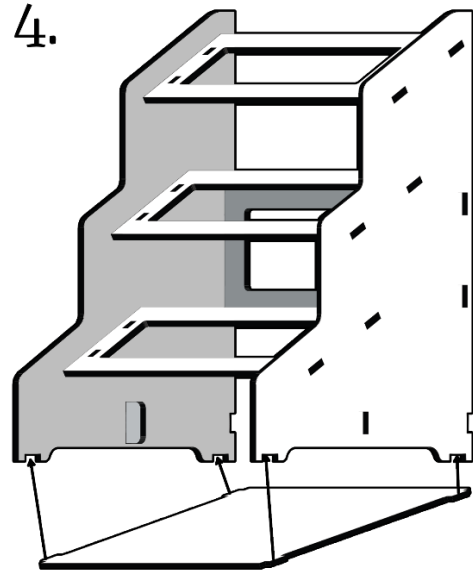

# TRAY HOLDERS INSTALLATION

A. HALF TRAY HOLDER

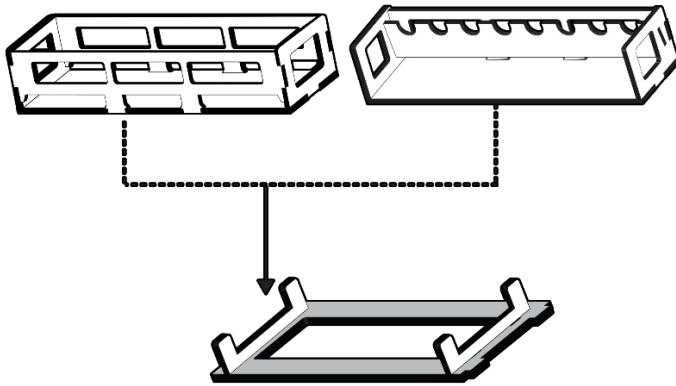

B. SLOT TRAY HOLDER

